



ISSN NO. 2320-5407

Journal homepage: <http://www.journalijar.com>

INTERNATIONAL JOURNAL
OF ADVANCED RESEARCH

RESEARCH ARTICLE

Finite Element Analysis of Warm Deep Drawing Process for Rectangular Cup of AA1100 Aluminum Alloy

Thirunagari Srinivas¹, A. C. Reddy²

1.PG Student, Department of Mechanical Engineering, JNTUH College of Engineering, Kukatpally, Hyderabad, India.

2. Professor, Department of Mechanical Engineering, JNTUH College of Engineering, Kukatpally, Hyderabad, India.

Manuscript Info

Manuscript History:

Received: 14 April 2015
Final Accepted: 25 May 2015
Published Online: June 2015

Key words:

Warm deep drawing, AA1100, blank thickness, temperature, strain rate, Coefficient of friction, damage.

*Corresponding Author

Thirunagari Srinivas

Copy Right, IJAR, 2015,. All rights reserved

Abstract

In this present work, a statistical approach based on Taguchi techniques and finite element analysis were adopted to determine the influence of sheet thickness, temperature, coefficient of friction and strain rate on the formability of cups from AA1100 aluminum alloy using warm deep drawing process. The major control factors which influence the quality of the rectangular cup have been found to be temperature and strain rate of the deep drawing process.

INTRODUCTION

Many investigations have been carried out to obtain an optimal blank shape that can be deformed into the near-net shape. Chung et al. (1997) have proposed a direct design method based on an ideal forming theory to get an initial blank shape. Toros et al. (2008) have developed an analytical model to evaluate deep drawing process at elevated temperatures and under different blank holder pressure (BHP) and identified that temperature, punch speed, BHP, and friction are the main factors that influence formability. Chennakesava Reddy et al. (2012) have carried out the experimental characterization on the warm deep drawing process of extra-deep drawing (EDD) steel. The results of the experimentation conclude that the extent of thinning at punch corner radius is lower in the warm deep-cup drawing process of EDD steel at 200°C. Chennakesava Reddy et al. (2012) in another work have simulated that the cup drawing process with an implicit finite element analysis. The effect of local thinning on the cup drawing has been investigated. The thinning is observed on the vertical walls of the cup. Reverse super plastic blow forming of a Ti-6Al-4V sheet has been simulated using finite element method to achieve the optimized control of thickness variation (Chennakesava Reddy, 2006). The strain hardening rate and fracture toughness are usually affected by strain rate and temperature. Chennakesava Reddy (2011) has used Taguchi technique which can save the cost of experimentation to optimize the extrusion process of 6063 aluminum alloy. Industrial pure aluminum cannot be heat strengthened, through increased intensity of cold deformation, the only form of heat treatment is annealing. 1100 aluminium alloy is mechanically strongest alloy in the series of 1xxx. At the same time, it keeps the benefits of being relatively lightly alloyed (compared to other series), such as high electrical conductivity, corrosion resistance, and workability. This alloy is commercially pure aluminum with excellent forming characteristics. Forming, either hot or cold, is readily accomplished with this alloy. In the annealed condition the alloy can be cold worked extensively without an intermediate anneal. This alloy is commonly used in spun hollowware, fin stock, heat

exchanger fins, dials and name plates, cooking utensils, decorative parts, giftware, rivets and reflectors, and in sheet metal work.

The objective of the present work is to optimize the warm deep drawing process of AA1100 aluminum alloy using Taguchi technique for the rectangular cups. In this present work, a statistical approach based on Taguchi and ANOVA techniques was adopted to determine the merit of each of the process parameter on the formability of deep drawn rectangular cup. All the experimental results have been verified using D-FORM software.

1. Materials and Methods

AA1100 aluminum alloy was used to fabricate deep drawing cups. The tensile and yield strengths of this alloy are 110 and 105 MPa respectively. The elastic modulus is 70 GPa. The Poisson's ratio is 0.33. The percent elongation is 12. The control parameters are those parameters that a manufacturer can control the design of the product, and the design of process. The levels chosen for the control parameters were in the operational range of AA1100 aluminum alloy using deep drawing process. Each of the four control parameters was studied at three levels. The chosen control parameters are summarized in table 1. The orthogonal array (OA), L9 was selected for the present work. The parameters were assigned to the various columns of O.A. The assignment of parameters along with the OA matrix is given in table 2.

1.1 Design and fabrication of deep drawn rectangular cups

The initial dimensions of the rectangular cup without corner and edge radii are shown in figure 1. The blank size was calculated by equating the surface area of the finished drawn cup with the area of the blank. The blank dimensions are obtained by:

$$2h(l + b) + lb = l_b b_b \quad (1)$$

where, l and l_b are the lengths the rectangular cup and the blank respectively; b and b_b are widths of the rectangular cup and the blank respectively; h is the height of cup.

In the present the dimensions of the cup are as follows:

Cup top length, $l = 60$ mm

Cup top width, $b = 40$ mm

Height of the cup, $h = 75$ mm.

$$b_b = b - 2(r_{ep} + t) + 2r_c \quad (2)$$

$$l_b = l - 2(r_{ep} + t) + 2r_c$$

where, r_{ep} is the edge radius of the punch, r_c is the blank radius and t is the thickness of the blank.

In order to avoid wrinkling in the rectangular cup, the blank must be given corner radius, r_c which can be expressed as follows:

$$r_c = \sqrt{r_{cp}^2 + 2r_{cp}h - 1.41r_{cp}r_{ep}} \quad (3)$$

where, r_{cp} is the punch side corner radius.

The length and width of the punch are equal to those of the cup. The height of the punch is the height of the cup. The drawing punch must have corner radius exceeding one-tenth of the cup top length. The radius joining the bottom to the sides, r_{ep} generally ranges from three to eight times the blank thickness (t). In the present work, the corner and edge punch radii are taken as below:

$$r_{cp} = l/5 \text{ and } r_{ep} = 5t \quad (4)$$

The material flow in drawing may render some flange thickening and thinning of walls of the cup inevitable. The space for drawing is kept bigger than the sheet thickness. This space is called die clearance.

$$\text{Clearance, } c_d = t \pm \mu\sqrt{10t} \quad (5)$$

where μ is the coefficient of friction.

The length of the die is obtained from the following equation:

$$l_d = l + 2c_d \quad (6)$$

The width of the die is obtained from the following equation:

$$b_d = b + 2c_d \quad (7)$$

The height of the die is the height of the cup.

The corner radius of the die is obtained by the addition of clearance to the punch corner radius. The edge radius of the die is eight times the blank thickness.

1.2 Finite element analysis

The finite element modeling and analysis was carried using D-FORM 3D software. The rectangular sheet blank was created with desired dimensions. The rectangular top punch and bottom hollow die were modeled as shown in figure 2 with appropriate inner and outer dimensions using UNIGRAPHICS software. The sheet blank was meshed with tetrahedral elements (Chennakesava, 2008). The modeling parameters of deep drawing process for trial were as follows:

Number of elements for the blank: 7088

Number of nodes for the blank: 2472

Top die polygons: 604

Bottom die polygons: 1096.

The rectangular cup operation during different steps is shown in figure 3. The contact between blank and punch, die and blank holder were coupled as contact pair. The mechanical interaction between the contact surfaces was assumed to be frictional contact. The finite element analysis was chosen to find the effective stress, height of the cup, and damage of the cup. The finite element analysis was conceded to run using D-FORM 3D software according to the design of experiments for the purpose of validating the results of experimentation.

2. Results and Discussion

Two trials were carried out with mesh sizes for each experiment.

2.1 Influence of control factors on effective Stress

Table 3 gives the ANOVA (analysis of variation) summary of raw data. The Fisher's test column establishes all the parameters (A, B, C and D) accepted at 90% confidence level. The percent contribution indicates that the factor D, strain rate, all by itself contributes 77.62% towards the variation. The blank thickness (A), temperature (B) and coefficient of friction (C) contribute 11.06%, 8.63% and 2.56% of the total variation observed.

The influence of control factors on the effective stress is shown figure 4. The effective stress of the rectangular cups is found to be maximum of 114.01MPa for blank thickness of 1.3mm as shown in figure 4(a). The effective stress of the rectangular cups is found to be minimum of 95.25MPa at temperature of 300°C as shown in figure 4(b). The effective stress of the rectangular cups is high of 108.427MPa for friction coefficient of 0.075 as shown in figure 4(c). The effective stress decreases with an increase of strain rate as shown in figure 4(d). The effective stresses induced in the rectangular cups under different trial conditions are shown in figure 5. The equivalent stresses induced in the trials 1, 2, 3, 5, 6, 7 and 9 are 119.28MPa, 113.18MPa, 72.38MPa, 119.79MPa, 124.62MPa, 119.28MPa and 113.94MPa, respectively. The equivalent stresses induced in the trials 4 and 8 are 98.97MPa and 53.62MPa respectively. The rectangular cups are successful with trials 3 and 8. Even though the equivalent stress induced in the trial 3 is 72.38MPa, the rectangular cup is failed due to high temperature of 500°C.

2.2 Influence of control factors on height of rectangular cup

Table 4 gives the ANOVA (analysis of variation) summary of raw data. The Fisher's test column establishes all the parameters (A, B, C and D) accepted at 90% confidence level. The percent contribution indicates that the factor D, strain rate, contributes 56.33% towards the variation. The blank thickness (A), temperature (B) and coefficient of friction (C) tender 21.81%, 17.46% and 4.26% respectively of variation on the cup height.

The influence of control factors on the cup height is shown figure 6. The cup height of the rectangular cups increases with an increase of blank thickness 6(a). The cup height of the rectangular cups is minimum of 53.35mm at temperature of 300°C as shown in figure 6(b). The coefficient of friction of 0.075 gives the cup height of 64.39mm as shown in n figure 6(c). The strain rate of 100 imparts the cup height of 47.22mm as shown in figure 6(d). The height of the rectangular cups under different trial conditions are shown in figure 7. For the rectangular cups drawn with trials conditions of 1, 2, 3, 5, 6 and 7, the cup heights are 15.92mm, 11.66mm and 71.70mm, 19.62mm, 39.74mm and 38.89mm, respectively. For the rectangular cups drawn with trials conditions of 4, 8 and 9, the cup heights are 77.76, 76.91mm, and 75.85mm, respectively. However, the trial 9 is failed because of tear at the top edge.

2.3 Influence of control factors on damage of rectangular cup

Table 5 gives the ANOVA (analysis of variation) summary of raw data. The Fisher's test column establishes all the parameters (A, B, C and D) accepted at 90% confidence level. The percent contribution indicates that the factor D, strain rate, contributes all by itself over 59.68% of the total variation. The blank thickness (A), temperature (B) and coefficient of friction (C) contribute 11.17%, 2.71% and 26.43% respectively on the variation of the cup damage.

The effect of control factors on the damage of cup are shown in figure 8. The damage of cups increases with an increase of the blank thickness as shown in figure 8(a). The damage of the cups decreases with an increase of temperature as shown in figure 8(b). The damage of cups is lowest for the coefficient of friction of 0.075 as shown in figure 8(c). The biggest damage of the cups is observed with the strain rate of 100 as shown in figure 8(d). The damage of the rectangular cups under different trial conditions are shown in figure 9. For the rectangular cups drawn with trials conditions of 1, 2, 5, 6, and 7, the damage of cups are 4.96%, 6.53%, 14.78%, 13.19% and 18.38%, respectively. Even though the trial condition of 3 has the damage of 0.47% the cup is failed during final stage drawing operation. The failure in this case is due to inadequate punch radius. For the rectangular cups drawn with trials conditions of 4, 8 and 9, the damage of cups are 0.23%, 0% and 2.35%, respectively. The biggest damage is observed with trial conditions of 7 on account of room temperature (30°C) and high coefficient of friction (0.1) and insufficient strain rate of the deep drawing process. For the damage of the rectangular cups drawn with operating conditions of trial 1, the reasons are owing to room temperature of the deep drawing process. The cups drawn with conditions of trials 2 and 6 are failed due to strain rate of 100. The high coefficient of friction results in the damage of cups drawn with operating conditions of trial 5. The forming limit diagram, as shown in figure 10, shows that the cups drawn with trials 1, 2, 3, 5 and 7 have wrinkles. It is also observed from figure 5 that the von Mises stresses for the cups drawn under trials 1, 2, 5, 6, 7 and 9 exceed the yield strength of the material, thus these cups undergo the plastic deformation. For the remaining cups the von Mises stress is less than the yield strength (105 MPa) of the material. However, the cup drawn under trial 8 is successful. The failure of other cups is due to the effect of drawing process parameters.

3. Conclusions

The successful rectangular cups with zero damage of 1.5mm blank thickness were obtained with operating conditions of 300°C, temperature; 0.05, coefficient of friction; and 500, strain rate. The successful rectangular cups of 1.2mm blank thickness were obtained with operating conditions of 30°C, temperature; 0.075, coefficient of friction; and 500, strain rate. The factors which attribute the success of cups have been found to be the drawing operations at 300°C temperature with strain rate of 500mm/mm/sec.

Acknowledgment

The authors wish to thank University Grants Commission (UGC), New Delhi, India for financial assisting this project.

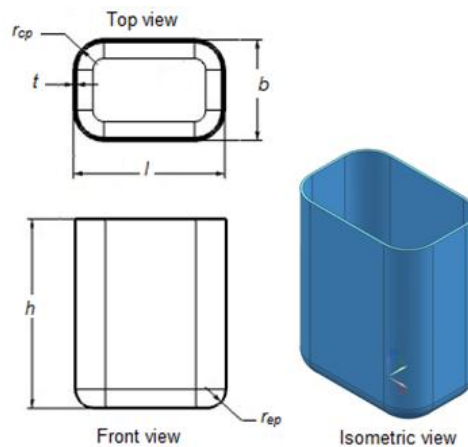

Figure 1: Initial dimensions (with corner & edge radii) of the rectangular cup.

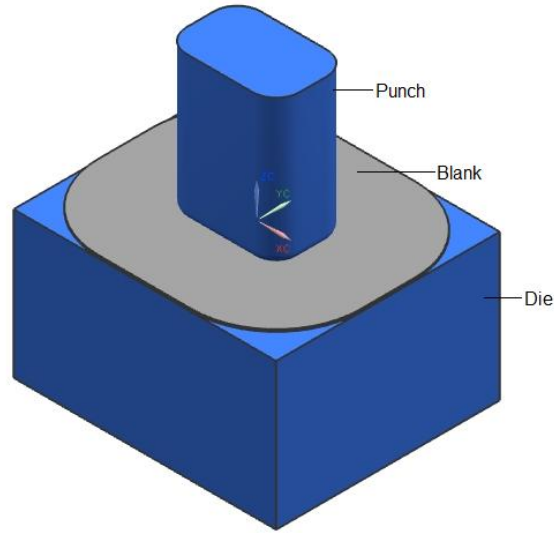

Figure 2: Blank, punch and die

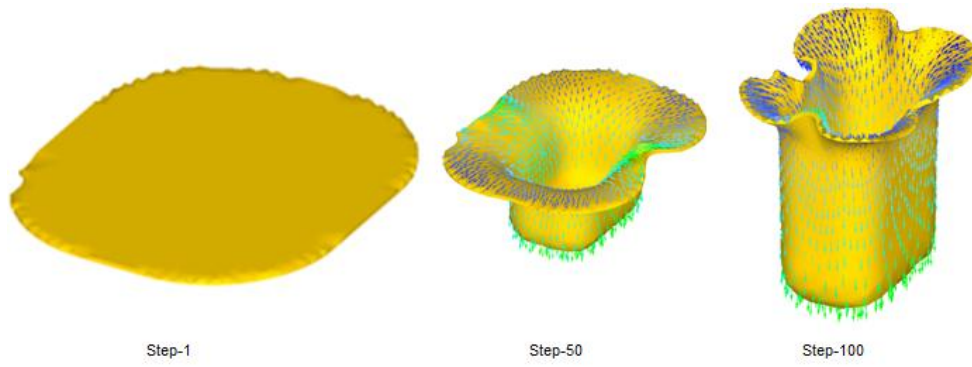

Figure 3: Rectangular cup drawing at different steps.

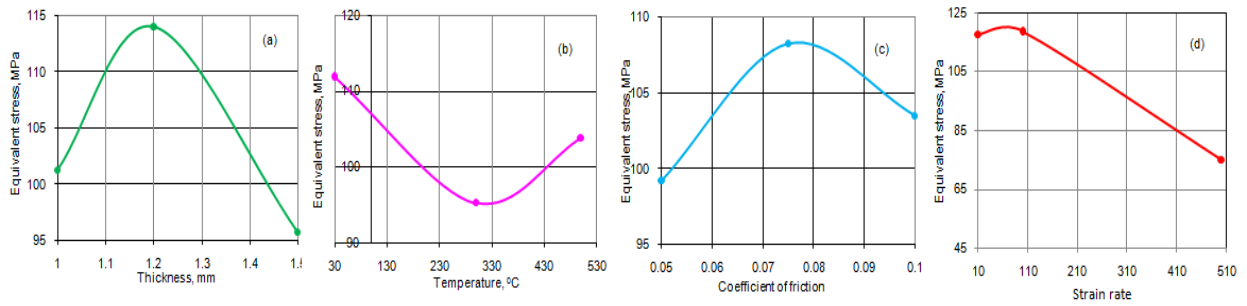

Figure 4: Effect of control factors on the effective stress.

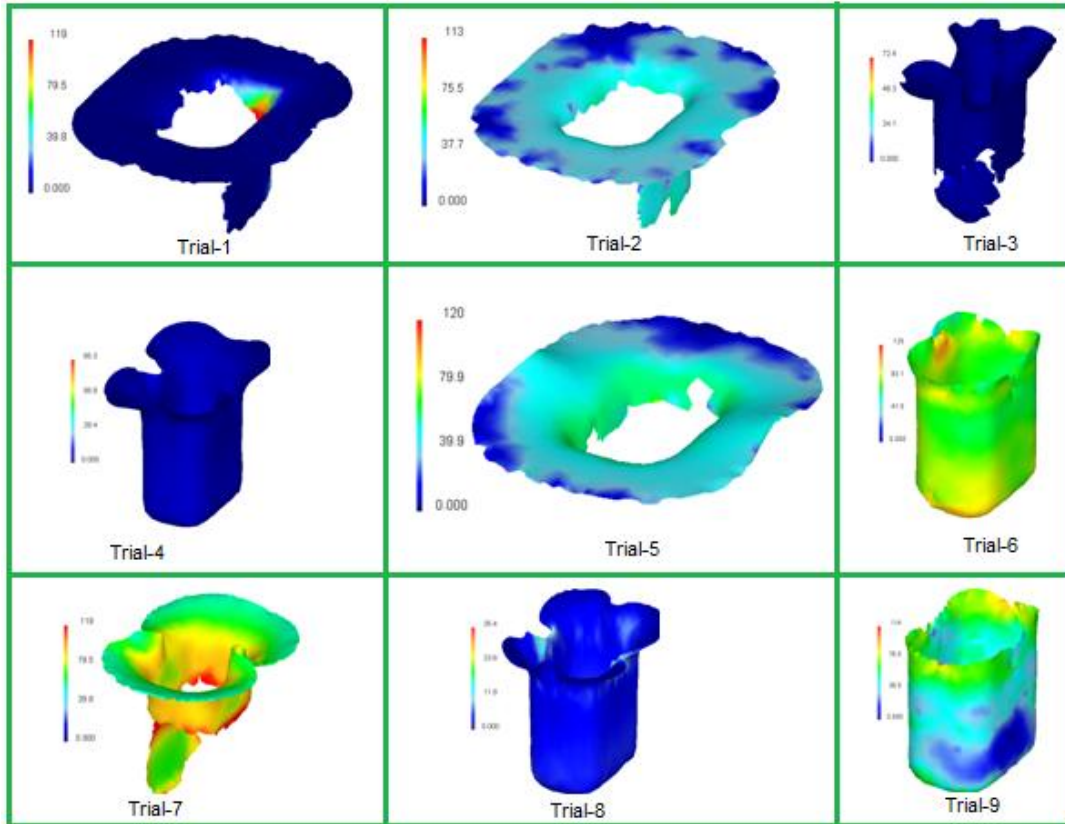

Figure 5: Effective stress in rectangular cups under different operating conditions.

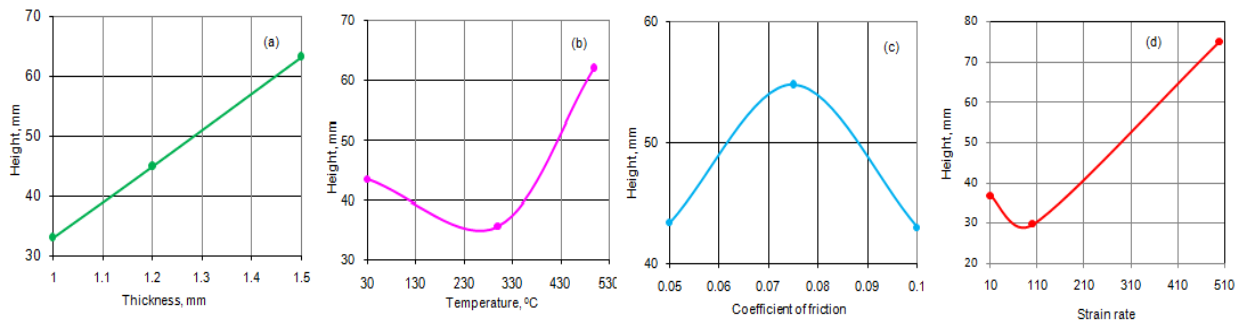

Figure 6: Effect of control factors on the cup height.

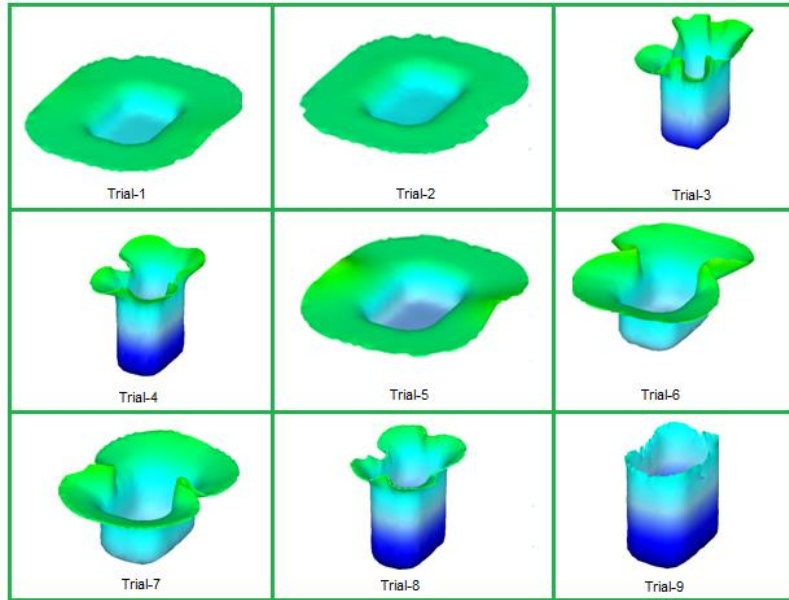

Figure 7: Heights of rectangular cups under different operating conditions.

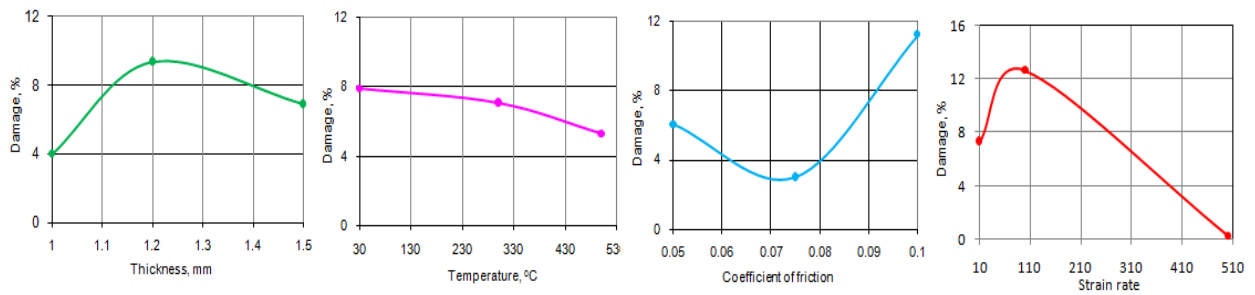

Figure 8: Effect of control factors on the cup damage.

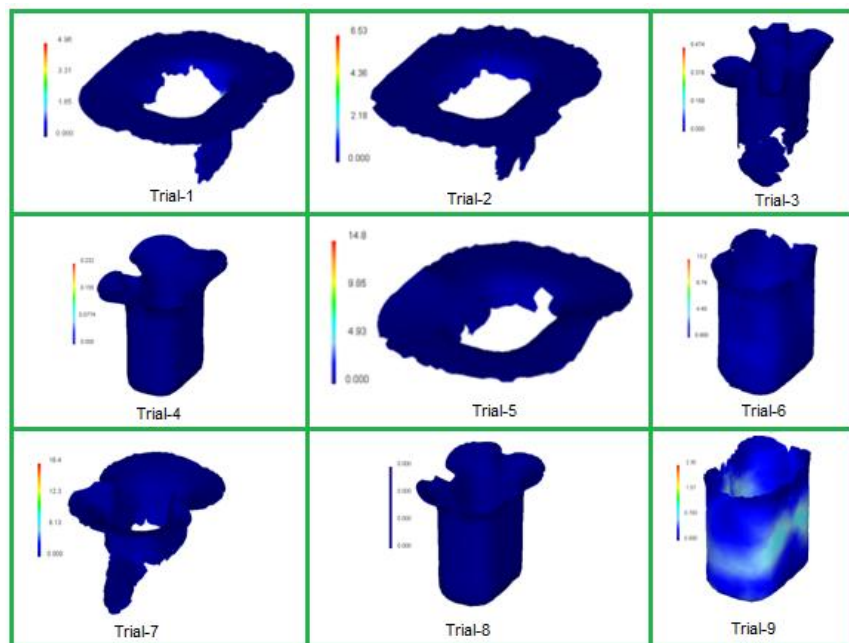

Figure 9: Damage in rectangular cups under different operating conditions.

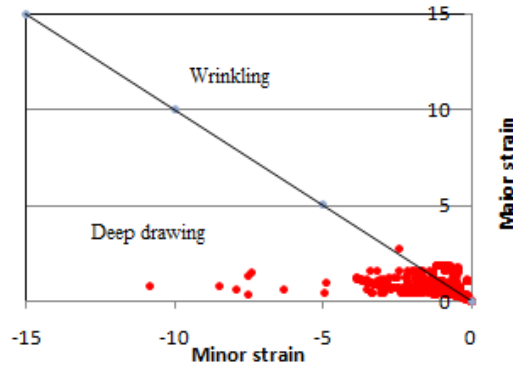

Figure10: forming limit diagram of cups

Table 1: Control Parameters and Levels

Factor	Symbol	Level-1	Level-2	Level-3
Thickness, mm	A	1.00	1.20	1.50
Temperature, 0C	B	30	300	500
Coefficient of Friction	C	0.05	0.075	0.1
Strain rate	D	10	100	500

Table 2: Orthogonal Array (L9) and control parameters

Treat No.	A	B	C	D
1	1	1	1	1
2	1	2	2	2
3	1	3	3	3
4	2	1	2	3
5	2	2	3	1
6	2	3	1	2
7	3	1	3	2
8	3	2	1	3
9	3	3	2	1

Table 3: ANOVA summary of the effective stress

Source	Sum 1	Sum 2	Sum 3	SS	v	V	F	P
A	607.337	684.0739	574.1109	1060.25	2	530.13	706.84	11.06
B	671.1624	571.5197	622.8397	827.64	2	413.82	551.76	8.63
C	595.1861	649.5942	620.7414	247	2	123.5	164.6667	2.56
D	704.6884	711.4136	449.4197	7436.01	4	1859	2478.667	77.62
Error	2578.374	2616.601	2267.112	5.251584	7	0.75	1	0.13
T	2556.955	2375.652	1976.019	9576.152	17			100

Note: SS is the sum of square, v is the degrees of freedom, V is the variance, F is the Fisher's ratio, P is the percentage of contribution and T is the sum squares due to total variation.

Table 4: ANOVA summary of the rectangular cup heights.

Source	Sum 1	Sum 2	Sum 3	SS	v	V	F	P
A	198.3283	269.9451	379.4184	2772.6	2	1386.3	1332.981	21.81
B	260.8041	214.0294	372.8583	2220.58	2	1110.29	1067.587	17.46
C	260.4079	329.1452	258.1386	542.89	2	271.45	261.0096	4.26
D	219.9051	177.7427	450.0439	7160.52	4	1790.13	1721.279	56.33
Error	939.4454	990.8624	1460.459	7.281953	7	1.04	1	0.14
T	939.4454	990.8624	1460.459	12703.87	17			100

Table 5: ANOVA summary of the rectangular cup damages.

Source	Sum 1	Sum 2	Sum 3	SS	v	V	F	P
A	23.89075	56.18367	41.39317	87.11	2	43.55	13006.31	11.17
B	47.2895	42.43882	31.73927	21.11	2	10.56	3153.769	2.71
C	36.27938	17.99466	67.19355	206.15	2	103.08	30785.09	26.43
D	44.16886	75.88251	1.416222	465.48	4	116.37	34754.18	59.68
Error				0.023439	7	0.003348	1	0.01
T	151.6285	192.4997	141.7422	779.8734	17			100

References

- Chennakesava Reddy, A., Kishen Kumar Reddy, T., Vidya Sagar, M. (2012).** Experimental characterization of warm deep drawing process for EDD steel, *Int. J. of Multidisciplinary Res. & Adv. Eng.* 4:53-62.
- Chennakesava Reddy, A. (2012).** Evaluation of local thinning during cup drawing of gas cylinder steel using isotropic criteria, *Int. J. of Eng. & Mat. Sci.*, 5:71-76.
- Chennakesava Reddy, A. (2006).** Finite element analysis of reverse superplastic blow forming of Ti-Al-4V alloy for optimized control of thickness variation using ABAQUS, *J. Manuf. Eng.*, 1: 06-09.
- Chennakesava Reddy, A. (2011).** Optimization of Extrusion Process of Alloy 6063 Using Taguchi Technique, *Int. J. of Multidisciplinary Res. & Adv. Eng.*, 3:173-190.
- Chennakesava R Alavala, (2006).** "FEM: Basic Concepts and Applications," PHI Learning Pvt. Ltd.
- Chung, K., Barlat, F., and Brem, J.C. (1997).** Blank shape design for a planar anisotropy sheet based on ideal forming design theory and FEM analysis, *International Journal of Mechanical Sciences*, 39:617-633.
- Toros S, Ozturk F., and Ilyas Kacar. (2008).** Review of warm forming of aluminum-magnesium alloys, *J.Mater. Process. Technol.*, 207:1-12.